



MODEL: PFTX 350-4

4-Pass Steam Packaged Firetube Boiler



Ratings & Performance Data

Horsepower 350							
Steam Storage, ft ³	59.4	Natural Gas Flow, SCFH (1,000 Btu/ft ³)**	14,233				
Steam Disengaging Area, ft ²	75.0	Combustion Air (15% Excess), SCFM***	2,604				
Total Heating Surface, ft ²	1,756	Flue Gas Flow Rate, lb/hr***	12,412				
Furnace Outside Diameter, in	40.0	Stack Flue Gas Velocity, ft/min***	2,109				
Furnace Heat Release Rate, Btu/ft ³ hr**	153,000	#2 Oil Flow, gal/hr (140,000 BTU/gal)**	98.0				
Total Combustion Volume, ft ³	134.3	#6 Oil Flow, gal/hr (150,000 BTU/gal)**	90.8				
Total Heat Release Rate, Btu/ft ³ hr**	106,000	Flue Gas Side Pressure Drop, in. H ₂ O	3.9				
Water Content N.W.L., gal	2,193	Water Content Flooded, gal.	2,637				
Approx. Dry Weight 15#, lb	24,200	Approx. Operating Weight 15#, lb.	43,000				
Approx. Dry Weight 150#, lb	27,300	Approx. Operating Weight 150#, lb.	46,100				
Approx. Dry Weight 200#, lb	30,500	Approx. Operating Weight 200#, lb.	49,300				
Approx. Dry Weight 250#, lb	34,600	Approx. Operating Weight 250#, lb.	53,400				
Approx. Dry Weight 300#, lb	38,200	Approx. Operating Weight 300#, lb.	57,000				
Performance Data							
Operating Pressure (psig)	Steam Rate (lb/hr)	Natural Gas		#2 Oil		#6 Oil	
		Stack Temp (F)	%Eff	Stack Temp (F)	%Eff	Stack Temp (F)	%Eff
10	12,155	301	84.8	312	87.9	321	88.6
50	11,919	358	83.3	370	86.4	380	87.1
100	11,792	398	82.3	410	85.4	421	86.0
150	11,721	426	81.6	438	84.7	450	85.3
200	11,676	448	81.0	460	84.1	473	84.7
250	11,648	467	80.6	478	83.6	492	84.2
300	11,630	483	80.2	494	83.2	509	83.8
*Based on 228°F feedwater and 3% O ₂ , ** Values calculated at 100 psi operating pressure, ***Calculated Firing Natural Gas							

MODEL: PFTX 350-4

Base Diagram

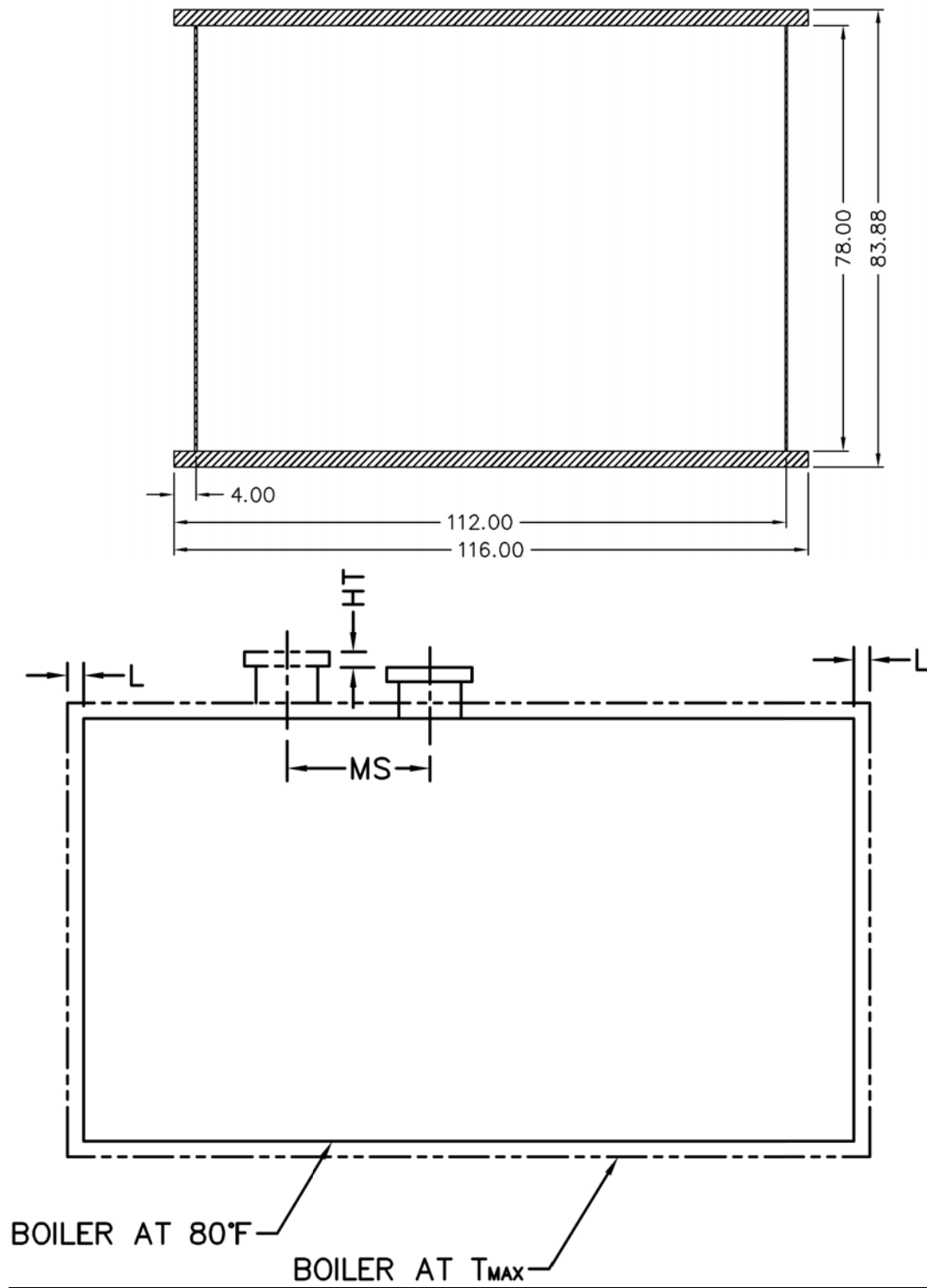

Thermal Expansion					
psig	15	150	200	250	300
Metal T _{MAX} (F)	240	366	388	406	421
L (in)	0.088	0.147	0.159	0.168	0.176
MS (in)	0.006	0.010	0.011	0.012	0.012
HT (in)	0.089	0.150	0.162	0.171	0.180

MODEL: PFTX 350-4

Nozzle Loadings

Maximum Allowable Load on Boiler Steam Nozzle					
	15# Design	150# Design	200# Design	250# Design	300# Design
F_{RRF} , lb	7,260	3,165	4,340	4,125	4,245
M_{RCM} , in-lb	43,065	28,560	47,580	41,280	50,270
M_{RLM} , in-lb	78,070	23,460	37,255	37,255	42,035

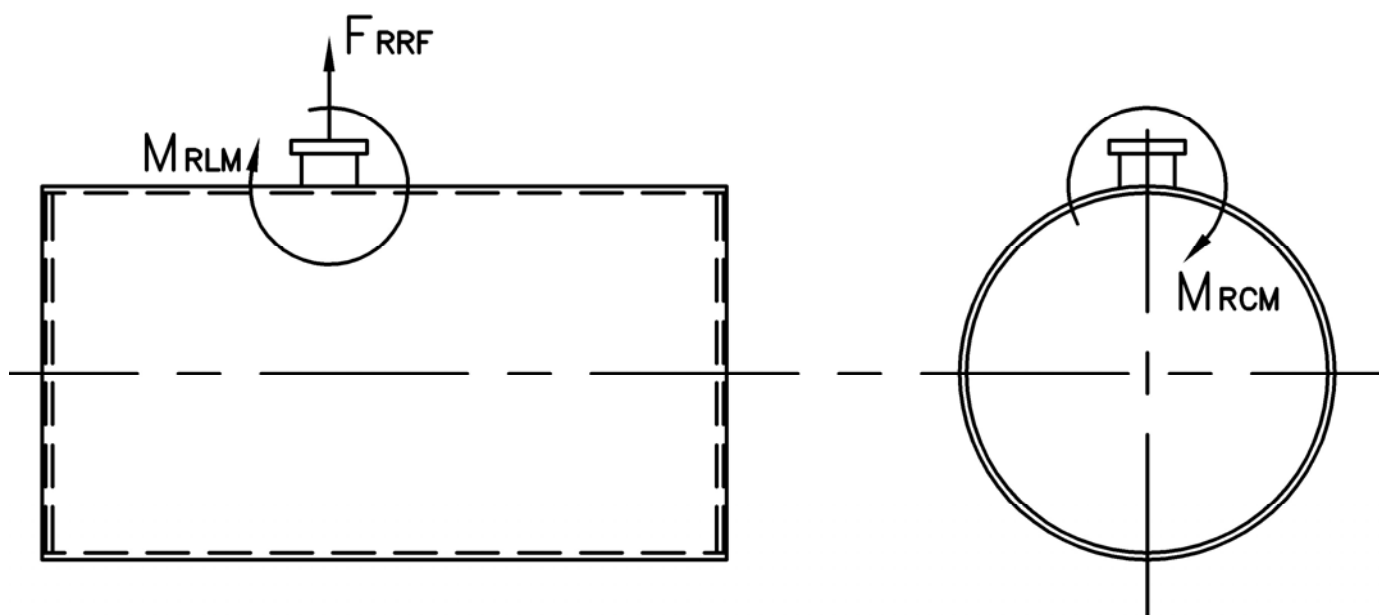

Distributed By:



300 Pine Street
P.O. Box 300
Ferrysburg, MI 49409-0300
Telephone: (616) 842-5050
Net: www.johnstonboiler.com

Printed Feb. 2008