

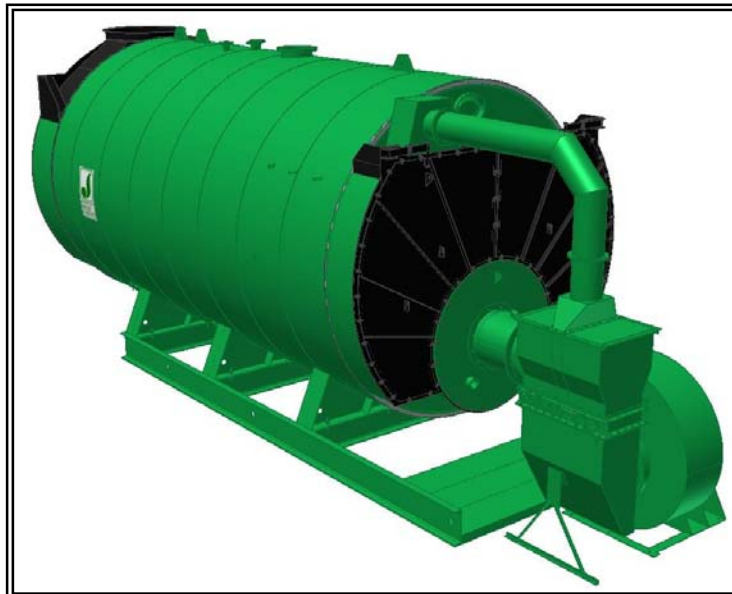

MODEL: PFTS 1800-3

3-Pass Steam Packaged Firetube Boiler



Ratings & Performance Data

Horsepower 1800							
Steam Storage, ft ³	209.4	Natural Gas Flow, SCFH (1,000 Btu/ft ³)**	73,036				
Steam Disengaging Area, ft ²	174.4	Combustion Air (15% Excess), SCFM***	13,364				
Total Heating Surface, ft ²	8,962	Flue Gas Flow Rate, lb/hr***	63,692				
Furnace Outside Diameter, in	66.5	Stack Flue Gas Velocity, ft/min***	2,077				
Furnace Heat Release Rate, Btu/ft ³ hr**	187,000	#2 Oil Flow, gal/hr (140,000 BTU/gal)**	503.2				
Total Combustion Volume, ft ³	581.4	#6 Oil Flow, gal/hr (150,000 BTU/gal)**	465.8				
Total Heat Release Rate, Btu/ft ³ hr**	126,000	Flue Gas Side Pressure Drop, in. H ₂ O	4.8				
Water Content N.W.L., gal	8,567	Water Content Flooded, gal.	10,133				
Approx. Dry Weight 15#, lb	98,800	Approx. Operating Weight 15#, lb.	171,400				
Approx. Dry Weight 150#, lb	119,000	Approx. Operating Weight 150#, lb.	191,600				
Approx. Dry Weight 200#, lb	132,000	Approx. Operating Weight 200#, lb.	204,600				
Approx. Dry Weight 250#, lb	140,000	Approx. Operating Weight 250#, lb.	212,600				
Approx. Dry Weight 300#, lb	150,000	Approx. Operating Weight 300#, lb.	222,600				
Performance Data							
Operating Pressure (psig)	Steam Rate (lb/hr)	Natural Gas		#2 Oil		#6 Oil	
		Stack Temp (F)	%Eff	Stack Temp (F)	%Eff	Stack Temp (F)	%Eff
10	62,511	317	84.7	331	87.8	341	88.4
50	61,299	373	83.4	386	86.4	396	87.1
100	60,643	411	82.5	424	85.5	434	86.2
150	60,277	438	81.9	451	84.9	460	85.6
200	60,050	459	81.4	472	84.4	481	85.1
250	59,903	477	81.0	489	84.0	498	84.7
300	59,810	492	80.6	504	83.6	513	84.4
*Based on 228°F feedwater and 3% O ₂ , ** Values calculated at 100 psi operating pressure, ***Calculated Firing Natural Gas							

Drawings - 3-Pass Steam Packaged Firetube Boiler

Connection & Opening Schedule			
Conn.	Description	Type	Qty
FW	Feedwater Inlet	2.50 FNPT	2
MS*	Main Steam	12.00 300# RF	1
CB	Continuous Blowoff	1.00 FNPT	1
BD	Blowdown Outlet	2.00 FNPT	2
MW	Manway	12 X 16	1
HH	Hand Hole	4 X 6	7

*26.00 150#RF Flange on 15 psig Design

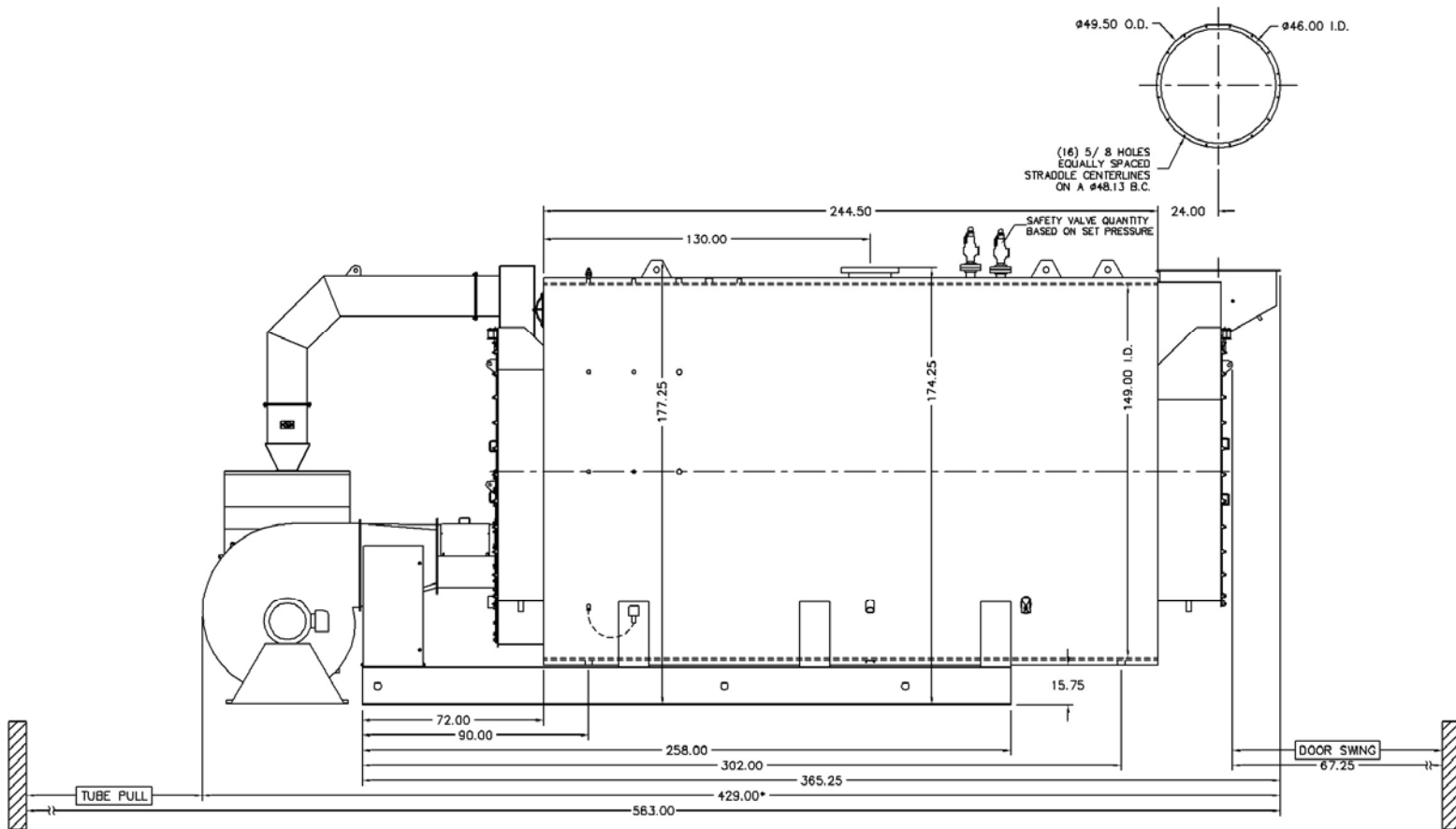
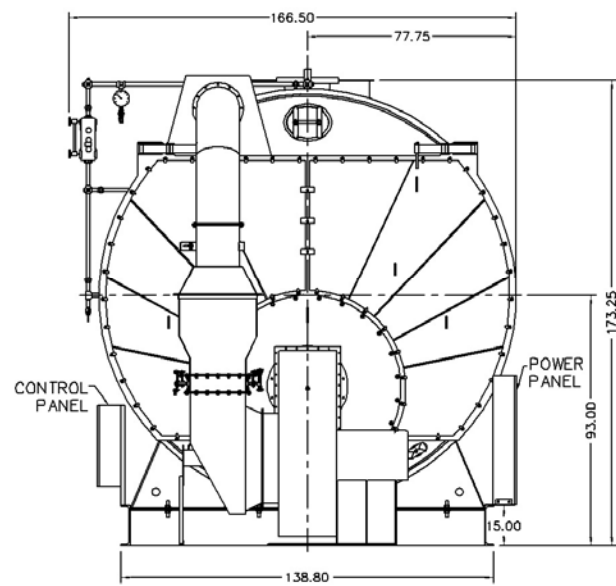

Notes:

150# Steam design shown, all dimensions given in inches.

Fuel piping and/or optional boiler trim may increase overall width.

Specifications subject to change to incorporate engineering advances.

*May vary on low-NO_x designs

MODEL: PFTS 1800-3

Base Diagram

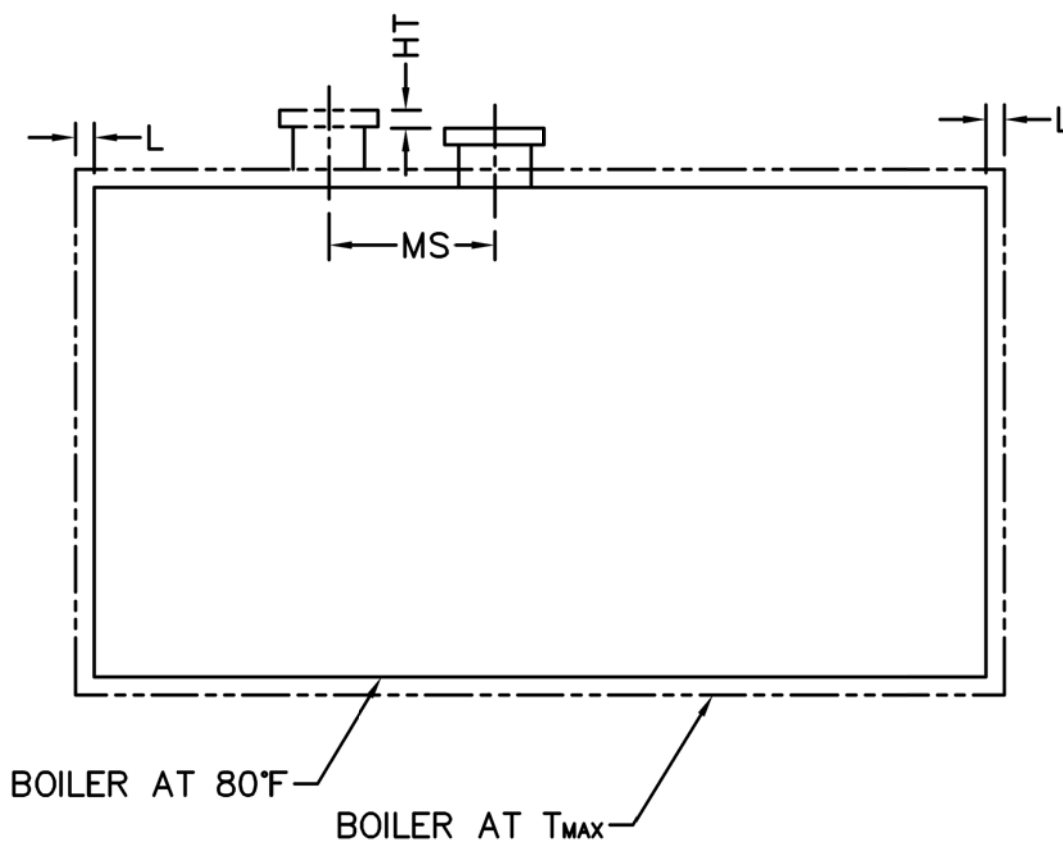
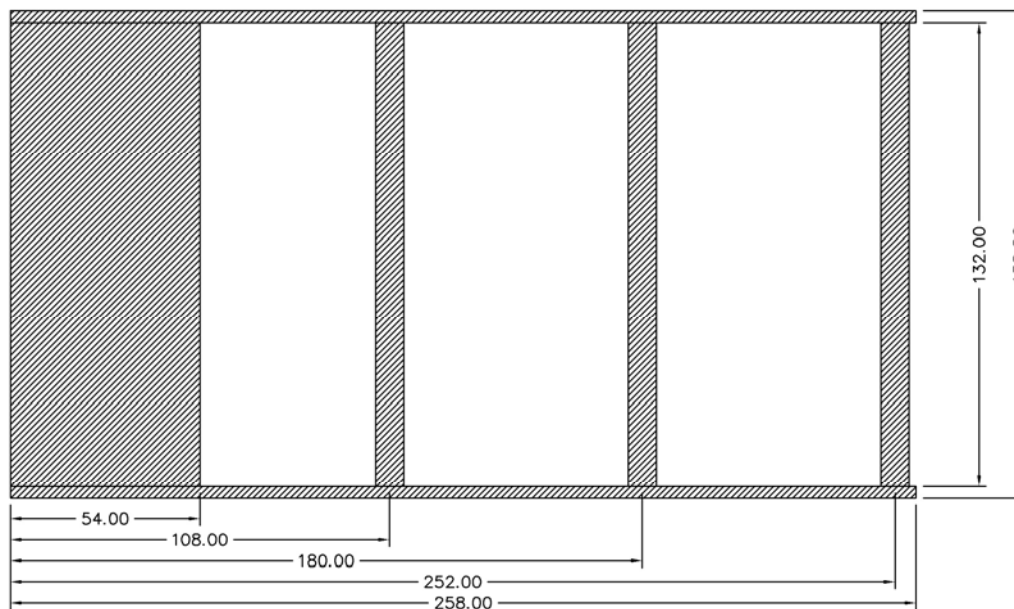

Thermal Expansion					
psig	15	150	200	250	300
Metal T_{MAX} (F)	250	366	388	406	422
L (in)	0.125	0.210	0.226	0.239	0.251
MS (in)	0.038	0.063	0.068	0.072	0.076
HT (in)	0.153	0.257	0.277	0.293	0.307

MODEL: PFTS 1800-3

Nozzle Loadings

Maximum Allowable Load on Boiler Steam Nozzle			
	15# Design	150# Design	200# Design
F_{RRF} , lb	14,680	6,429	11,515
M_{RCM} , in-lb	164,830	119,077	233,345
M_{RLM} , in-lb	382,145	96,100	169,885

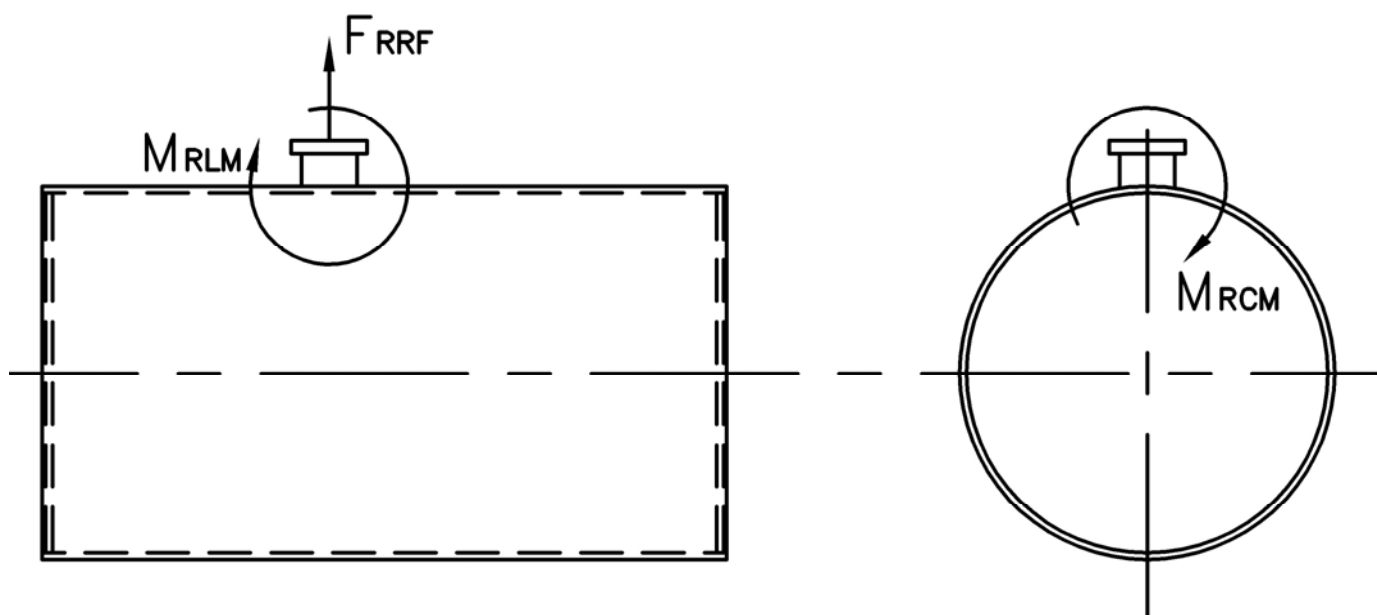

Distributed By:

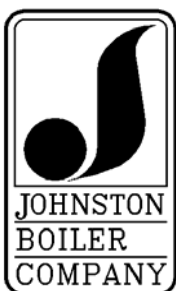

300 Pine Street
P.O. Box 300
Ferrysburg, MI 49409-0300
Telephone: (616) 842-5050
Net: www.johnstonboiler.com

Stack Emissions-Natural Gas (1,000 Btu/CF)				
	PPMv (Corr to 3% O ₂)	lb/MBtu	lb/hr @ Full Rate	Ton/Yr @ Full Rate
NO _x *	110	0.131	9.564	41.892
	30	0.036	2.608	11.425
	9	0.011	0.783	3.427
CO	50	0.037	2.68	11.752
CO ₂	2.55 lb/lb fuel	119.76	8,747	38,311
H ₂ O	2.03 lb/lb fuel	106.16	7,754	33,961
Stack Emissions-#2 Oil** (140,000 Btu/gal)				
NO _x	128	0.174	12.266	53.723
CO	50	0.037	2.588	11.336
CO ₂	3.20 lb/lb fuel	168.53	11,873	52,003
H ₂ O	1.12 lb/lb fuel	71.20	5,016	21,970

* 110 ppm "A" Burner, 30 ppm A-FGR Burner, 9 ppm FIR Burner
**0.02% fuel bound Nitrogen